

A) FEATURES

- 1) 1.5V Operate
- 2) Low Power Consumption
- 3) 4-digit LCD Calendar Clock With Temperature
Selectable for 12 or 24 Hour Format
Selectable for degC or degF Format
- 4) Date Display (Month / Date / Week)
- 5) Year Range is 1940-2099 (Default is 2001yr)
Auto Adjust Week
- 6) Measuring Temperature Range:-9 degC ~+70 degC or
+15.8degF ~+158degF
- 7) Temperature Display Resolution :0.1 degC
- 8) Accuracy :+/- 1 degC
- 9) Soldering Option for 30 sec Rotate Display or Fixed Display

B) OPERATION MODES

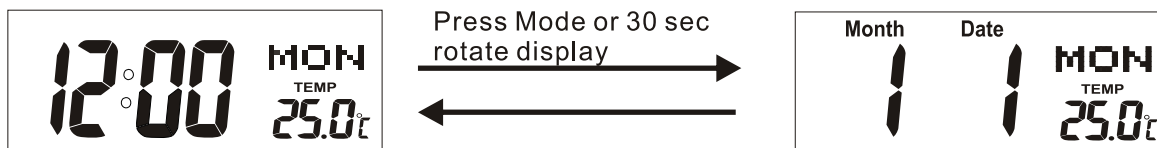

C) SETTING PROCEDURES

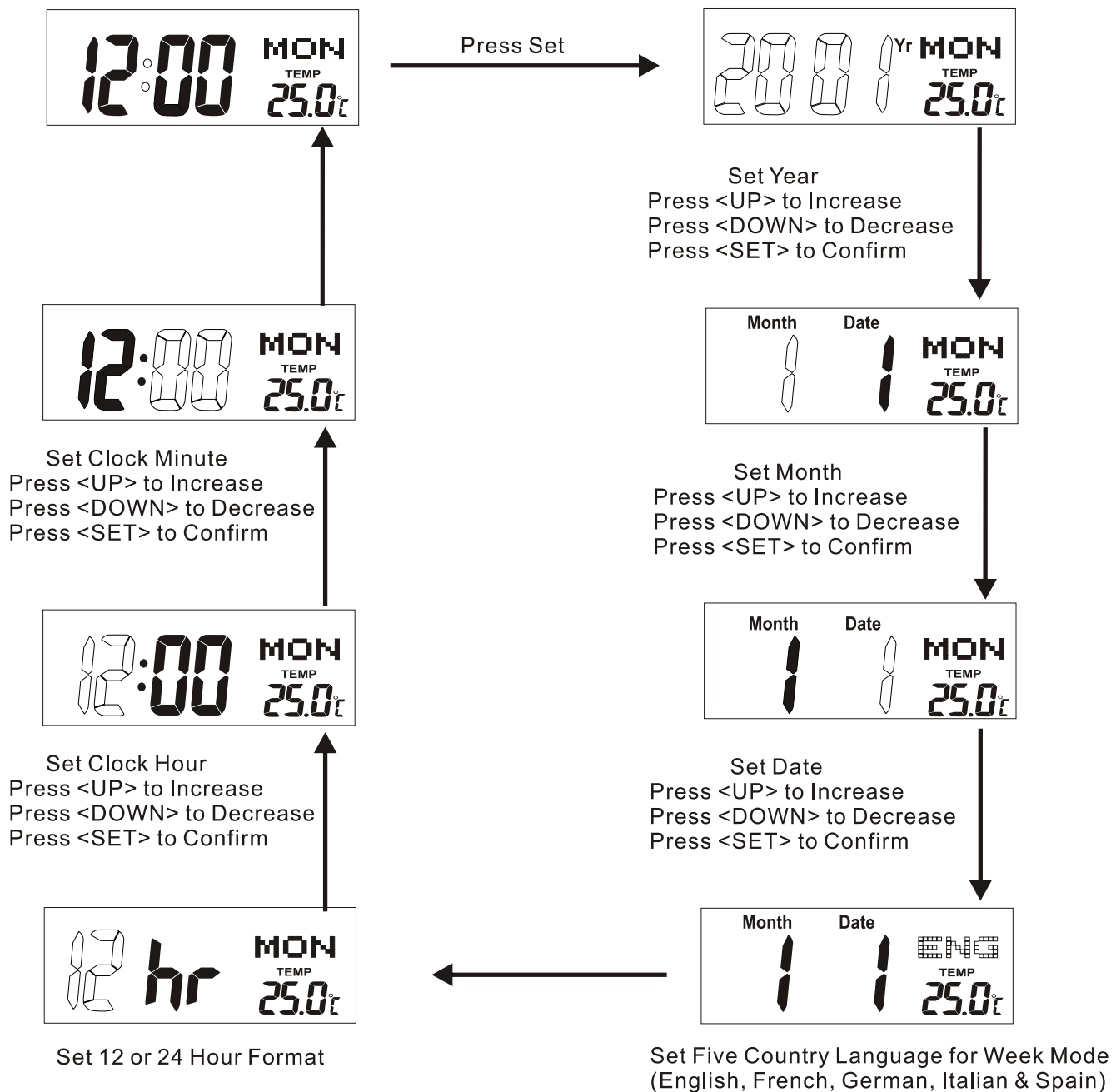

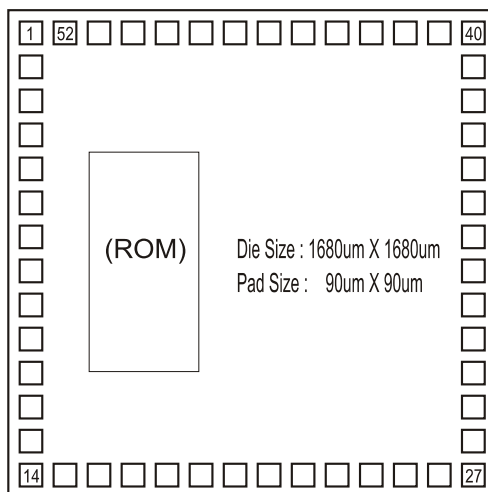

SUBSTRATE SHOULD BE CONNECTED TO GND

PIN ASSIGNMENT

NO	NAME	X	Y	NO	NAME	X	Y
1	BAK	77.5	1602.5	27	SEG13	1602.5	77.5
2	XIN	77.5	1472.5	28	SEG14	1602.5	207.5
3	XOUT	77.5	1357.5	29	SEG15	1602.5	322.5
4	GND	77.5	1242.5	30	SEG16	1602.5	437.5
5	VDD1	77.5	1127.5	31	SEG17	1602.5	552.5
6	VDD2	77.5	1012.5	32	SEG18	1602.5	667.5
7	VDD3	77.5	897.5	33	SEG19	1602.5	782.5
8	CUP1	77.5	782.5	34	SEG20	1602.5	897.5
9	CUP2	77.5	667.5	35	SEG21	1602.5	1012.5
10	COM1	77.5	552.5	36	SEG22	1602.5	1127.5
11	COM2	77.5	437.5	37	SEG23	1602.5	1242.5
12	COM3	77.5	322.5	38	SEG24	1602.5	1357.5
13	COM4	77.5	207.5	39	IOA2	1602.5	1472.5
14	COM5	77.5	77.5	40	IOA3	1602.5	1602.5
15	SEG1	207.5	77.5	41	SEG27	1472.5	1602.5
16	SEG2	322.5	77.5	42	SEG28	1357.5	1602.5
17	SEG3	437.5	77.5	43	SEG29	1242.5	1602.5
18	SEG4	552.5	77.5	44	SEG30	1127.5	1602.5
19	SEG5	667.5	77.5	45	SEG31	1012.5	1602.5
20	SEG6	782.5	77.5	46	SEG32	897.5	1602.5
21	SEG7	897.5	77.5	47	KI2	782.5	1602.5
22	SEG8	1012.5	77.5	48	IOC3	667.5	1602.5
23	SEG9	1127.5	77.5	49	IOC4	552.5	1602.5
24	SEG10	1242.5	77.5	50	RESET	437.5	1602.5
25	SEG11	1357.5	77.5	51	INT.	322.5	1602.5
26	SEG12	1472.5	77.5	52	N.C.	207.5	1602.5

DL6022

www.jfd-ic.com

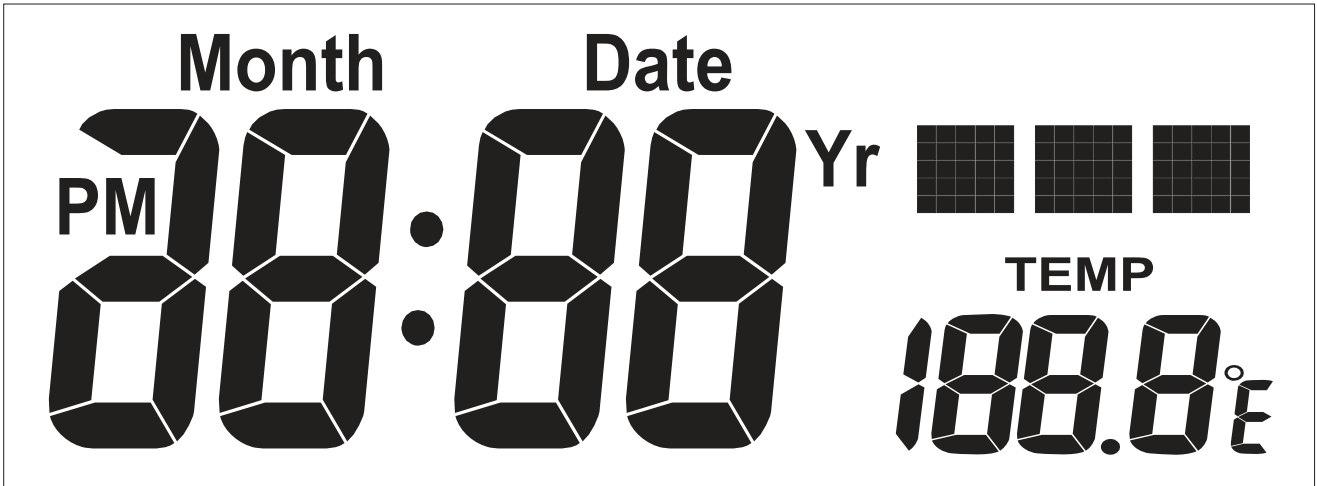

VLcd4.5v Duty 1/5 Bias 1/3

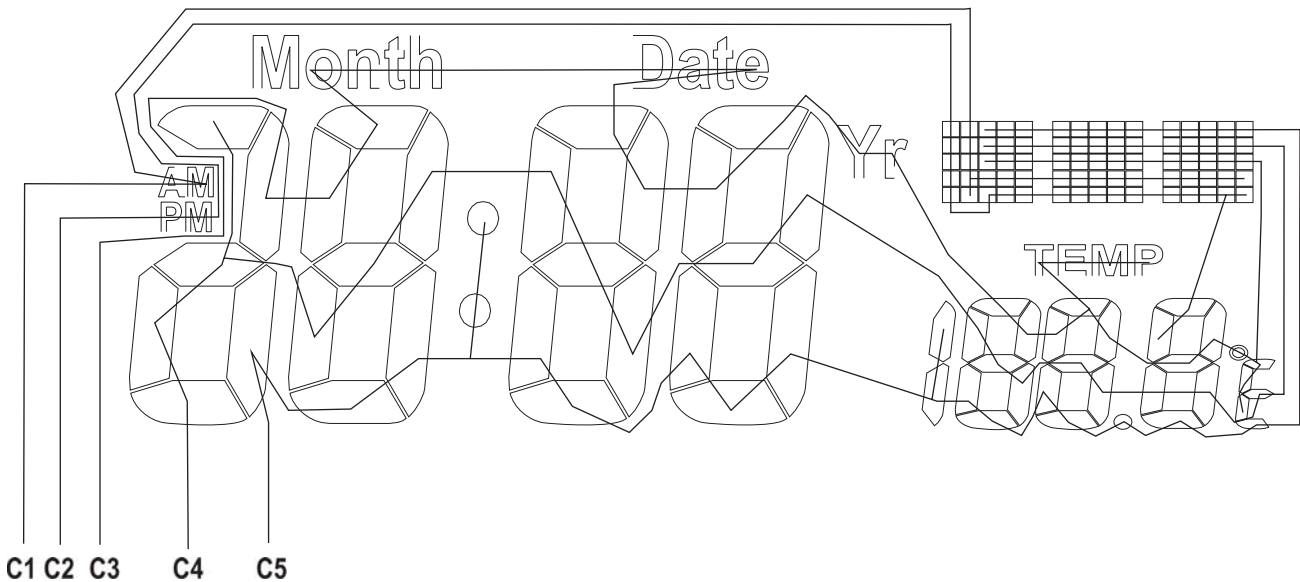
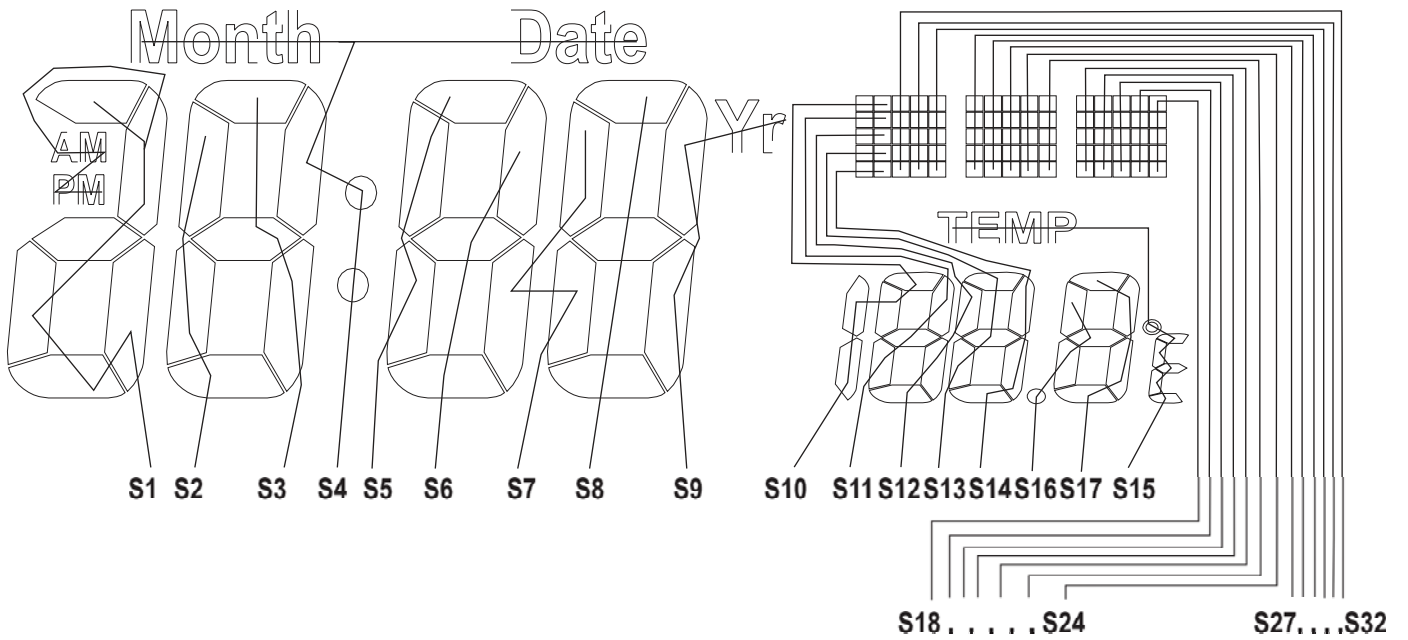

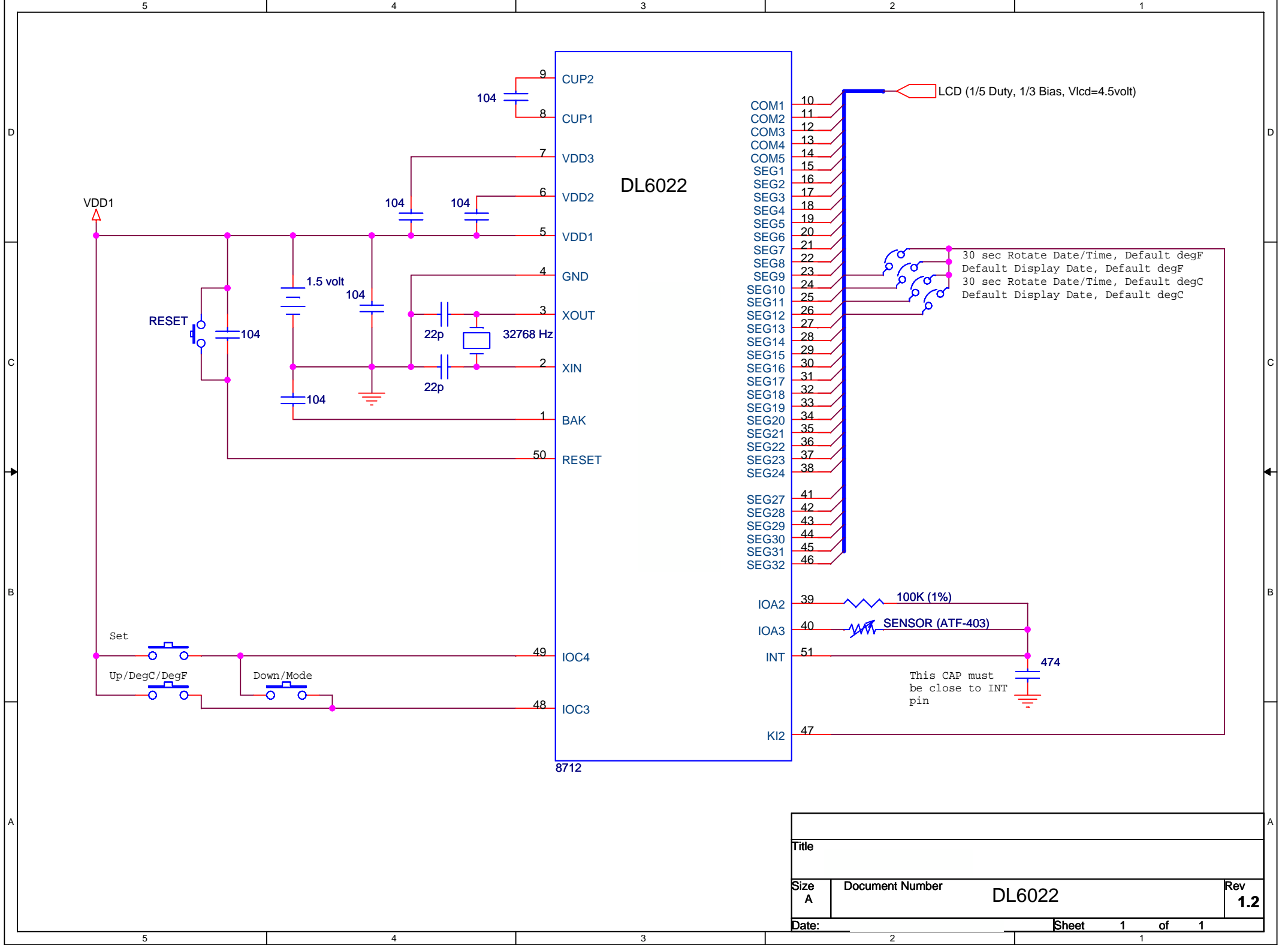

Title		
Size A	Document Number DL6022	Rev 1.2
Date:	Sheet	1 of 1